

- (A) Zastavbovy rozmer / In-built dimension / Baumaße
- (B) Litinový odvod kouře / Cast iron spigot / Der gusseiserne Rauchabgang
- (C) Centralní privod vzduchu / Central air inlet / Zentralluftzufuhr
- (D) Primární a sekundární vzduch / Primary and secondary air / Primärluft und Sekundärluft
- (L) Volná plocha prosklení / Free glass area / Freie Glassichtfläche

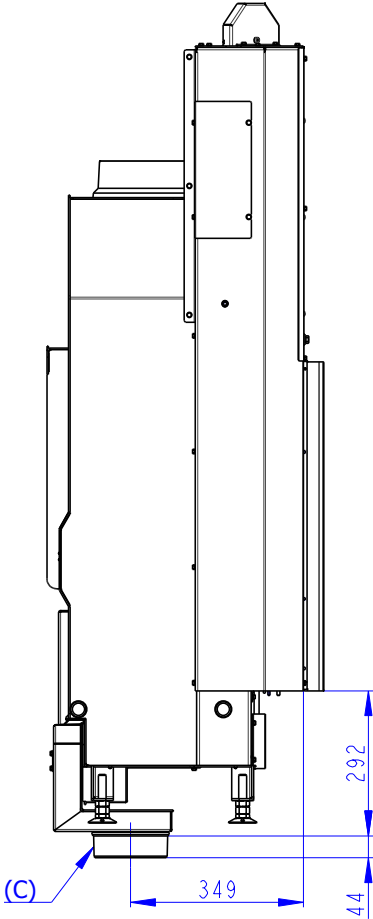

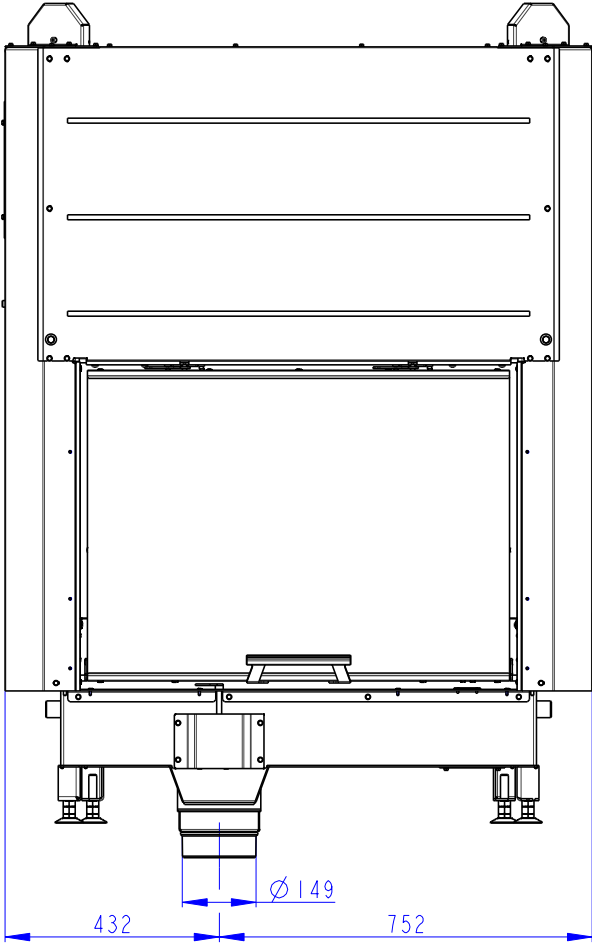

NELZE KOMBINOVAT SE SADAMI AKUMULACI AKKUM KV 02, AKKUM KV 03
UNABLE TO COMBINE WITH ACCUMULATION SETS AKKUM KV 02, AKKUM KV 03
NICHT KOMBINIERBAR MIT SPEICHERSATZ AKKUM KV 02, AKKUM KV 03

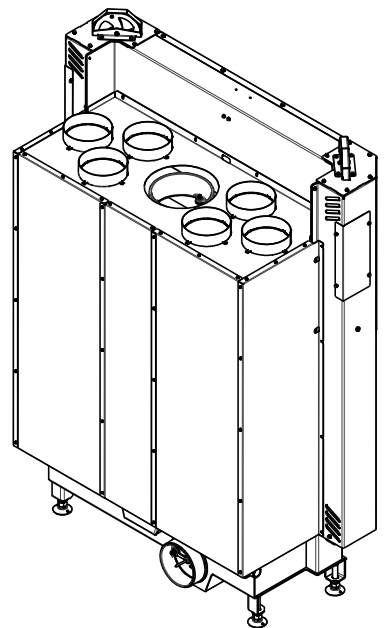
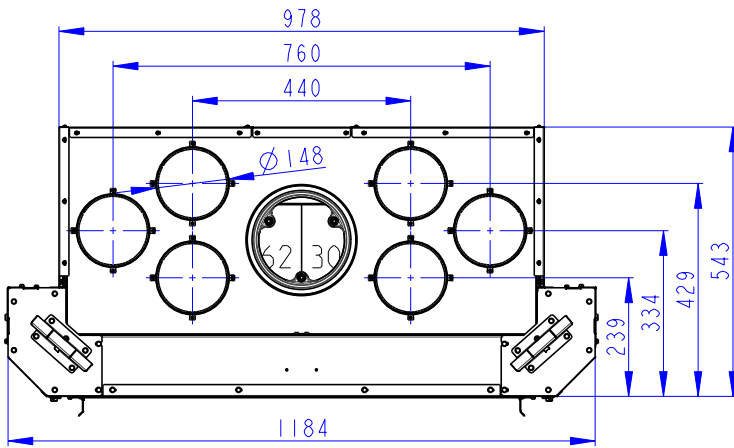
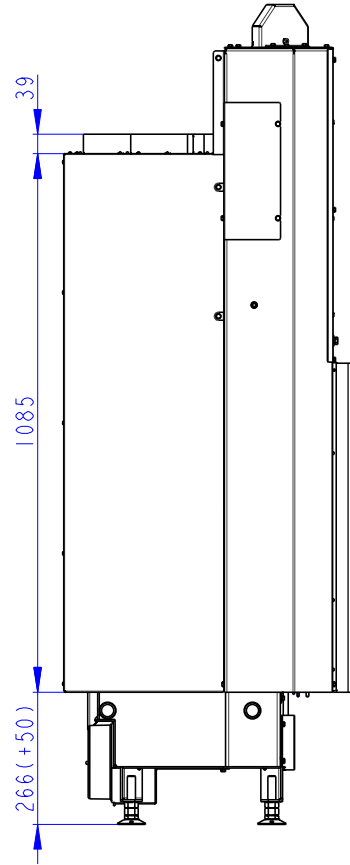
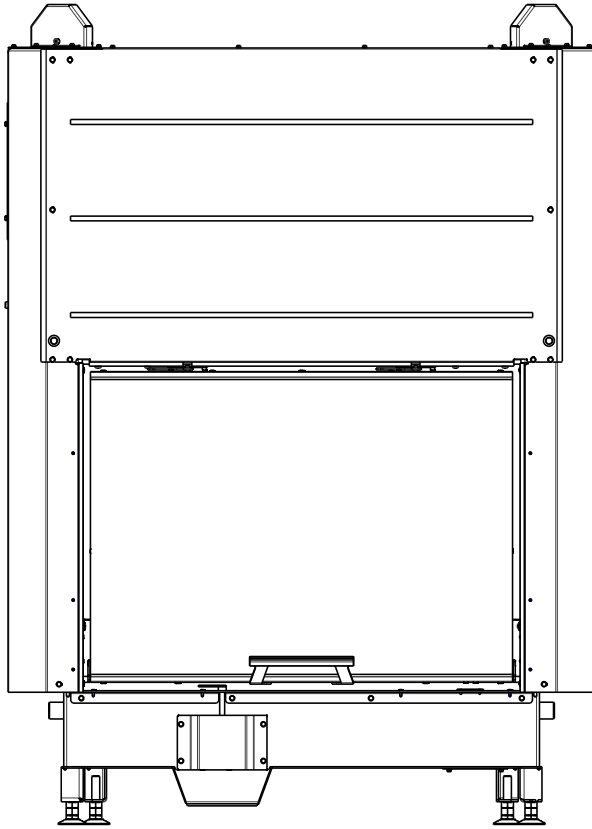